

PRO AS300D/500D (Digital)

USER MANUAL

TABLE OF CONTENT

1. Safety Precautions	1
2. Device Identification	3
3. System Overview	7
4. Control Panel Identification	8
5. Getting Started	
- Display Screen Menu	10
- Changing the Settings	14
- Fault Indicator on the control panel	23
- Controlling the Active Oxygen emission rate	27
- Installation of device	28
- Installation of nozzle	29
6. Basic Maintenance	31

SAFETY PRECAUTIONS

WARNINGS - *To reduce the risk of electrical shock, fire or injury:*

1. Do not use the device if the power cable or plug is damaged.
2. Do not insert any sharp or pointed object through the ventilation holes of the device.
3. Do not let unauthorized personnel to play with the device.
4. Do not immerse the device in water, or allow water or any fluids to enter through the ventilation holes.
5. When removing the power plug, always hold the plug and never pull the cable.
6. Do not remove the power plug when your hands are wet.
7. Remove the power plug from the wall socket before cleaning the device.
8. Do not modify, disassemble or repair this device without proper training and consulting the manual beforehand. Opening the device or tampering with it in any way without proper training will cause the Warranty to become void. If you encounter any problem with the device, please contact the nearest authorized Medklinn Service Centre.
9. Do not replace the electric plug or cut the power cable. Replacing the plug or cutting the power cable in any way will immediately cause the warranty to become void. Any subsequent fault in the operation of the device will not be covered by the Warranty, and repair and maintenance service will be chargeable.
10. If the power cable is damaged, contact an authorized Medklinn Service Centre for repairs immediately.
11. Do not wipe the device with benzene or paint thinner.

FOR FURTHER ASSISTANCE, PLEASE CALL OUR CUSTOMER SERVICE.

NOTE – Radio, TV or sensitive equipment interference:

If the device should cause interference to radio, television reception or any sensitive equipment, try to correct the interference by one or more of the following measures:

- Reorient or relocate the receiving antenna.
- Increase the distance between the device and radio/TV receiver/sensitive equipment.
- Connect the equipment into an outlet on a circuit different from that to which the receiver is connected.
- Consult the dealer or an experienced radio/TV technician for help.

Cautions during operation:

1. Place the device at least six feet from radio, television or electronic equipment. This is to minimize the possibility of interference with the equipment or the remote controller.
2. Do not cover the device in any way at all, particularly the ventilation holes. Doing so will cause excessive heat build-up and may result in a fire and irreparable damage to the device.
3. Ensure free flow of air around the device.
4. Avoid locations where the device is exposed to condensation due to rapid and drastic temperature fluctuations. The device should only be used in temperatures between 10°-35°C.
5. Effective cleaning by Active Oxygen requires adequate air exchange as they are created from oxygen. Regular air exchange will take place if the door or window is opened occasionally.
6. Do not use the device in small enclosed spaces where there is no or poor air circulation e.g. in wardrobes, closets or pantries.
7. Active Oxygen is very reactive, and there may be some loss of paint from poorly painted surfaces. To minimize this, do not place the nozzles directly against walls or other painted surfaces, and leave a space of at least two feet from these surfaces.
8. It is NOT recommended to place the nozzle directly too close to pets.

DEVICE IDENTIFICATION

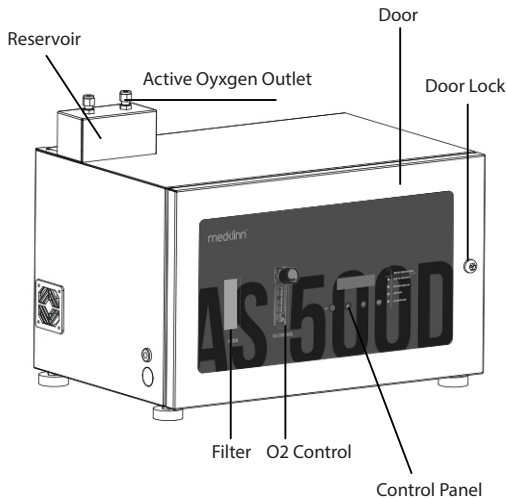

Medklinn O3 Hydro 5 (Front View)

Functional parts

O2 Control	Controls the amount of oxygen flowing into the device's ozone module
Filter	Filters the air supply
Reservoir	Collects any liquid formed from air condensation
Active Oxygen Outlet	Outlet for the generated Active Oxygen
Control Panel	Controls/Monitors the entire system
Door	Door of the device
Door Lock	Locks the device's door

DEVICE IDENTIFICATION

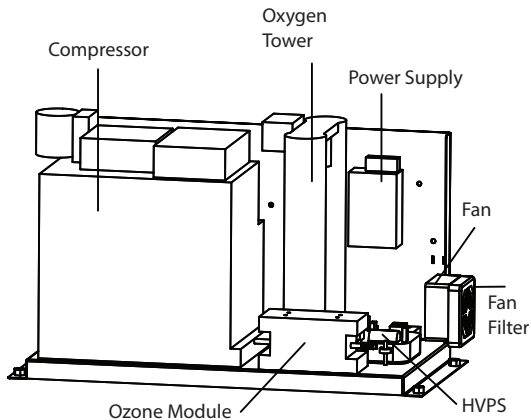

Medklinn PRO AS300D/500D
(Inner Compartment View)

Functional parts

Compressor	Pushes air into the device
Oxygen Tower	Increases oxygen purity in the air supply
Power Supply	Supplies power to the fan
Fan	Cools internal compartment temperature
Fan Filter	Filters dust from entering the inner compartment
HVPS	Supplies power to the ozone module
Ozone Module	Generates the Active Oxygen

DEVICE IDENTIFICATION

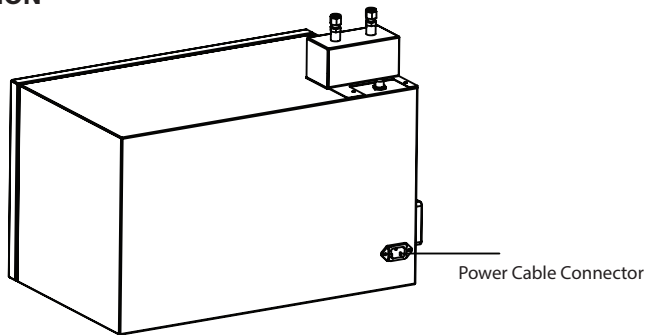

Medklinn PRO AS300D/500D (Back View)

Functional parts

Power Cable Connector:	Connector port for the power cable
-------------------------------	------------------------------------

DEVICE IDENTIFICATION

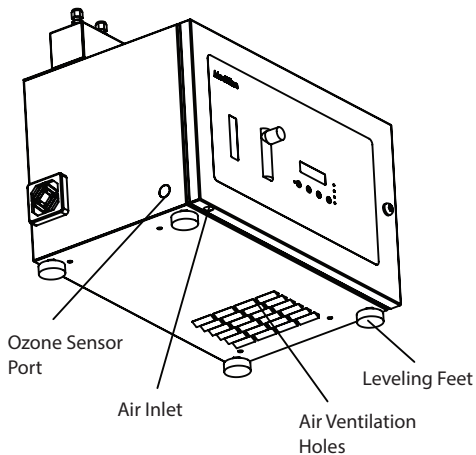

Medklinn PRO AS300D/500D (Bottom View)

Functional parts

Ozone Sensor Port	Port for the ozone sensor cable (Optional accessory)
Air Inlet	Incoming port for the air intake into the device. Avoid blocking this inlet.
Air Ventilation Holes	Holes for air to flow in/out of the inner compartment
Leveling Feet	Adjustable feet to control height of device on a surface

SYSTEM OVERVIEW

Medklinn PRO AS300D/500D converts supplied oxygen (O₂) into Active Oxygen (O₃ and O⁻). The Active Oxygen generated is nature's most powerful sterilizing force, killing up to 99% bacteria, viruses, allergens, moulds, and other pollutants from both air and surfaces in any indoor spaces.

When the Medklinn PRO AS300D/500D operates, the air is taken in by the compressor through the air inlet into the HEPA filter. This air is forced through a fine mesh filter that traps pollutants before passing into the oxygen tower, which compresses the air and removes nitrogen from it, thus increases the purity of oxygen (O₂) up to 90%.

The concentrated oxygen (O₂) is finally supplied to the ozone module which breaks it down to its Active Oxygen components (O₃ and O⁻) with the use of electricity. It is then released into the environment through the Active Oxygen outlet.

CONTROL PANEL IDENTIFICATION

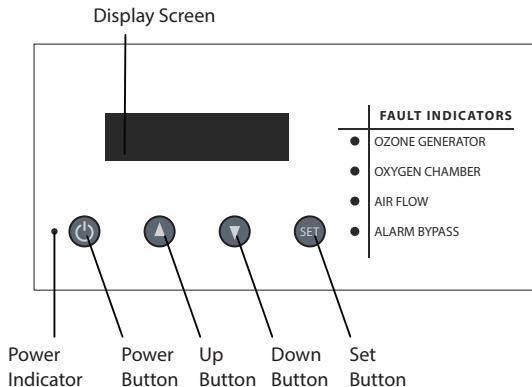

Functional parts

Display Screen	Displays information status of the device
Power Indicator	Shows that the device is ON/OFF
Power Button	To switch the device ON/OFF and works as BACK button in the menus
Up / Down Button	To scroll up and down in the menu
Set Button	To select options in the menu

CONTROL PANEL IDENTIFICATION

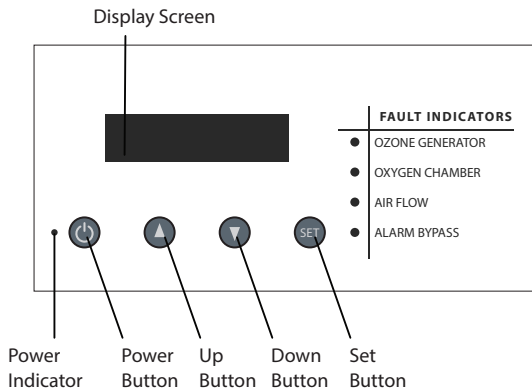

Fault indicators

Ozone Generator	Points to a problem with the ozone generator
Oxygen Chamber	Points to a problem with the oxygen chamber
Air Flow	Points to a problem with the air flow
Alarm Bypass	Shows that an alarm bypass was done and the device will continue running for another 30 days before shutting down

GETTING STARTED

1. Plug the power cord into the connector of the device and 110V-240V AC power outlet.

NOTE: Proper grounding for international plugs:

For safety precaution, international plugs must have proper grounding wire connected to the device.

2. Press the Power Button on the Control Panel to switch on the device
3. The Power Indicator and Display Screen will light up when the device is switched on.
4. The device's information status will be displayed one after another repeatedly on the Display Screen.

Display screen menu

1. CLOCK

Displays the current time on the device (hh:mm:ss).

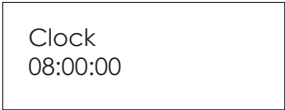

Clock
08:00:00

2. (a) MODE: NORMAL

Shows that the device is in standard operation mode.



MODE: NORMAL

(b) MODE: TEMPORARY

Shows that the device has an issue to be addressed and has 30 days remaining of operating time before it shuts down. Make a call to the nearest Medklinn's service center to address the issue.

MODE: TEMPORARY
REMAIN: 30 days

(c) MODE: STOPPED

Shows that the device has stopped operating. Make a call to the nearest Medklinn's service center to address the issue.

MODE: STOPPED
Call for service

3. P1

Shows the setting of Program 1. It includes the start time, end time, and the time interval of the device alternating from on to off for that duration.

start time end time
P1 8:00 - 12:00
10 ON, 30 OFF (MIN) — time interval

4. P2

Shows the setting of Program 2. It includes the start time, end time and shows that this current program is being disabled.

P2 12:00 - 14:00
Disabled

5. P3

Shows the setting of Program 3. It includes the start time, end time and shows that this current program is being disabled.

P3 15:00 - 17:00
Disabled

6. P24h

Shows the setting of Program 24h. It includes the start time, end time and the time interval of the device alternating from on to off for the entire 24 hour period.

P24h 00:00 - 24:00
10 ON, 10 OFF (MIN)

7. FLOW

Shows the flow rate of oxygen into the ozone module.

FLOW
1.5 LPM

8. O3 LVL at ROOM1 (Optional. Activated when ozone sensor is installed)

Shows the ozone level detected by ozone sensor 1.

O3 LVL at ROOM1

0.00PPM

9. O3 LVL at ROOM2 (Optional. Activated when ozone sensor is installed)

Shows the ozone level detected by ozone sensor 2.

O3 LVL at ROOM2

0.00PPM

10. O3 LVL at ROOM3 (Optional. Activated when ozone sensor is installed)

Shows the ozone level detected by ozone sensor 3.

O3 LVL at ROOM3

0.00PPM

11. The information above will be displayed one at a time in a 5 second rotation (depending on the administrator setting).

12. The information on the Display Screen can also be toggled through the Up/Down buttons on the Control Panel.

Changing the settings

1. Switch on the device by pressing Power on the Control Panel.
2. Wait until the information on the Display Screen is shown.
3. Press Set to enter into the main menu. Except the Display Screen, the other components stop operating while in this mode.

(i) Changing the clock time

4. Press Set on Clock Setting.
5. Press Up to change hour and Down to change minutes. The time format is in 24-hour clock mode.
6. Press Set to confirm on the time change. After 3 seconds, the display Setting Accepted will be shown.
7. Press any key to acknowledge the change.

Clock Setting

Edit Value
08:00:00

Setting Accepted
Press any key...

(ii) Changing the operation time

8. From step 3, press Down to go onto the next option in the main menu. The display Program Setting will be shown.
9. Press Set to change the Program Setting.
10. To set a single operation time for the entire 24 hours, press Down until Program 24h is shown and follow steps 12 - 16 only.
11. To set multiple operation times, press Down until Program 1, 2 and/or 3 are shown. Follow steps 17 - 31 to set up Program 1.

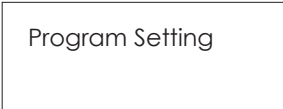

Program Setting

Program 24h

12. Press Set to configure settings of Program 24h.
13. Press Set to select ON time.



Program 24h



Edit Program 24h
ON Time

14. Press Up/Down to toggle the time interval wanted.

Disable	10minON, 10minOFF	10minON, 20minOFF	10minON, 30minOFF	10minON, 40minOFF	10minON, 50minOFF
Disable Program	Time 1	Time 2	Time 3	Time 4	Time 5
20minON, 10minOFF	20minON, 20minOFF	20minON, 30minOFF	20minON, 40minOFF	20minON, 50minOFF	30minON, 10minOFF
Time 6	Time 7	Time 8	Time 9	Time 10	Time 11
30minON, 20minOFF	30minON, 30minOFF	30minON, 40minOFF	30minON, 50minOFF	40minON, 10minOFF	40minON, 20minOFF
Time 12	Time 13	Time 14	Time 15	Time 16	Time 17
40minON, 30minOFF	40minON, 40minOFF	40minON, 50minOFF	50minON, 10minOFF	50minON, 20minOFF	50minON, 30minOFF
Time 18	Time 19	Time 20	Time 21	Time 22	Time 23
	50minON, 40minOFF	50minON, 50minOFF	ALL TIME ON		
	Time 24	Time 25	ON ALWAYS		

15. Press Set to select. There will be an asterisk beside the values to show that this particular time is selected.

16. Press Power twice to go back to main menu.

*10min ON,
30min OFF

Program 1

17. Press Set to configure settings of Program 1.

Program 1

18. Press Set to select ON time.

Edit Program 1
ON Time

19. Press Up/Down to toggle the time interval wanted.

Disable	10minON, 10minOFF	10minON, 20minOFF	10minON, 30minOFF	10minON, 40minOFF	10minON, 50minOFF
Disable Program	Time 1	Time 2	Time 3	Time 4	Time 5
20minON, 10minOFF	20minON, 20minOFF	20minON, 30minOFF	20minON, 40minOFF	20minON, 50minOFF	30minON, 10minOFF
Time 6	Time 7	Time 8	Time 9	Time 10	Time 11
30minON, 20minOFF	30minON, 30minOFF	30minON, 40minOFF	30minON, 50minOFF	40minON, 10minOFF	40minON, 20minOFF
Time 12	Time 13	Time 14	Time 15	Time 16	Time 17
40minON, 30minOFF	40minON, 40minOFF	40minON, 50minOFF	50minON, 10minOFF	50minON, 20minOFF	50minON, 30minOFF
Time 18	Time 19	Time 20	Time 21	Time 22	Time 23
	50minON, 40minOFF	50minON, 50minOFF	ALL TIME ON		
	Time 24	Time 25	ON ALWAYS		

20. Press Set to select. There will be an asterisk beside the values to show that this particular time is selected.

21. Press Power to go back to the previous menu.

*10min ON,
30min OFF

22. Press Down and then Set to enter Start Time configuration.

Edit Program 1
Start Time

23. Press Up to change hour and Down to change minutes.

Edit Value
08:00:00

24. Press Set to confirm on the start time. After 3 seconds, the display Setting Accepted will be shown.

25. Press any key to acknowledge the change.

Setting Accepted
Press any key...

26. Press Down and then press Set to enter End Time configuration.

Edit Program 1
End Time

27. Press Up to change hour and Down to change minutes.

Edit Value
12:00:00

28. Press Set to confirm on the end time. After 3 seconds, the display Setting Accepted will be shown.

29. Press any key to acknowledge the change.

30. Press Power to go back to the previous menu.

Setting Accepted
Press any key...

Program 2 and/or 3

31. Repeat steps 17 - 31 for Program 2 and/or 3 (if necessary).

NOTE - If Program 24h is enabled, Program 24h will be priority, followed by Program 1, Program 2 and Program 3

(iii) Changing the ozone (O₃) threshold cut-off (if applicable)

NOTE - This is to set the cut-off limit of Active Oxygen production into the surrounding air. Once it reaches the limit, the ozone sensor will automatically stop the device from operating. The device starts operating again when the Active Oxygen is below the cut-off limit. Only change the O₃ Threshold setting under direct supervision from Medklinn.

32. From step 3, press Down until you see O3 Threshold in the menu.

O3 Threshold

33. Press Set to enter O3 Threshold settings.

34. Press Set to configure settings for Sensor 1

O3 Threshold
(Sensor 1)

35. Press Up/Down to increase/decrease parts per million (ppm) levels by 0.01. The default value is at 0.05 ppm. The minimum and maximum values are shown below.

Min: 0.01 ppm Max: 1.00 ppm

Edit Value
0.05PPM

36. Press Set to confirm on the level of ozone threshold. After 3 seconds, the display Setting Accepted will be shown.

Setting Accepted
Press any key...

37. Press any key to acknowledge the change.

38. Press Power to go back to the previous menu.
39. Press Down to set up Sensor 2 and/or Sensor 3 (if necessary).
40. Repeat steps 35 - 39 to configure settings on Sensor 2 and Sensor 3.

NOTE - Only applies to Medklinn PRO AS300D/500D devices which have more than 1 sensor.

41. Press Power to go BACK to the previous menu.
42. Press Power again to exit from the setting menu.

NOTE - The Medklinn PRO AS300D/500D device will continue operating after exiting from the setting menu.

Fault Indicators on the Control Panel

Fault indicators appear to notify the user that there is a problem with the device. It is also accompanied with a buzzer sound. It directs the user to which component has failed.

Ozone Generator Fault

Condition: Buzzer sound emitted, red light on Ozone Generator, Display Screen shows ALARM: O3, Press v (Down) to mute.

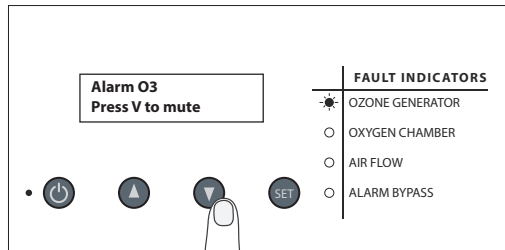

Steps to take:

1. Press Down to switch off the alarm.
2. Contact the nearest Medklinn service centre to arrange for maintenance service immediately.

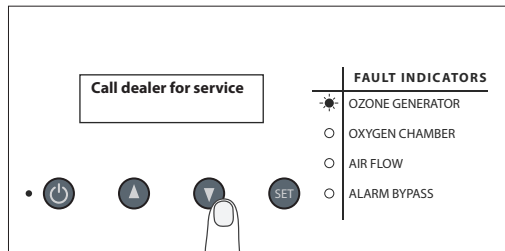

3. Meanwhile, the device will still continue to operate for the time stated on the Display Screen.

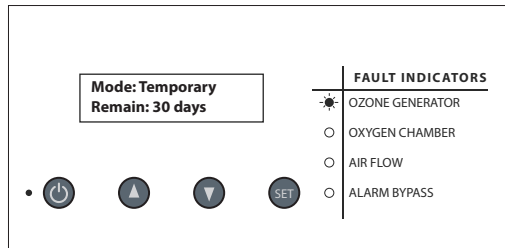

Oxygen Chamber Fault

Condition: Buzzer sound emitted, red light on Oxygen Chamber, Display Screen shows ALARM: O2, Press v (Down) to mute.

Steps to take:

1. Press Down to switch off the alarm.

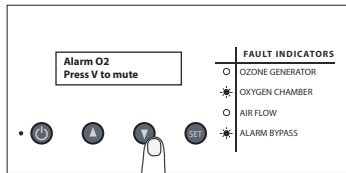

2. Contact the nearest Medklinn service centre to arrange for maintenance service immediately.

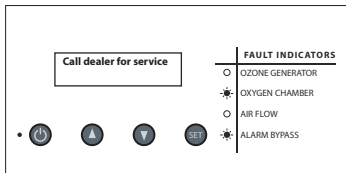

3. Meanwhile, the device will still continue to operate for the time stated on the Display Screen.

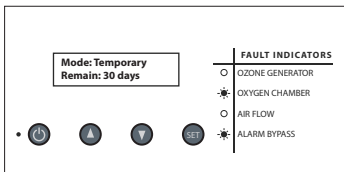

Air flow fault

Condition: Buzzer sound emitted, red light on Air Flow, Display Screen shows Mode: Stopped, Call for service, device has stopped operating.

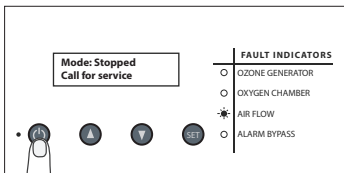

Steps to take:

1. Check to see if the O2 Control knob is not fully closed.
2. If it is, turn the O2 Control knob up. Press Power twice to switch the device off and on again. After 40 seconds, check to see if the device operates back in normal mode (without the fault status above). The fault is resolved when the device is operating in normal mode after 40 seconds.
3. If it is not, press Power to switch the device off and contact the nearest Medklinn service centre to arrange for maintenance service immediately.

Controlling the Active Oxygen emission rate

The Medklinn PRO AS300D/500D Active Oxygen emission rate is set depending on the total coverage area. It is controlled by 3 different methods:

1. O2 Control

- Turning the knob of the O2 Control to increase or decrease the level of Active Oxygen generation

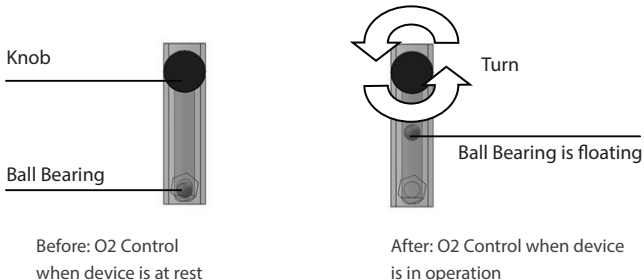

2. Programming the ON/OFF Time

- Using the programs P1, P2, P3 and/or P24h in the main menu to set the intervals of ON/OFF timing for the device. Refer to the section of Changing the operation time on page 15.

3. Ozone Sensor Cut-Off

- Using the ozone sensor and the program O3 Threshold to cut-off the generation of Active Oxygen at a level which is set by the user. Default cut-off level is at 0.05 parts per million (ppm). When the Active Oxygen levels reach the value limit, the ozone sensor will stop the device from operating. The device resumes operation once its levels drop down below the value limit.

Installation of Device

1. Mount a pair of 1HP air-condition brackets to the wall.

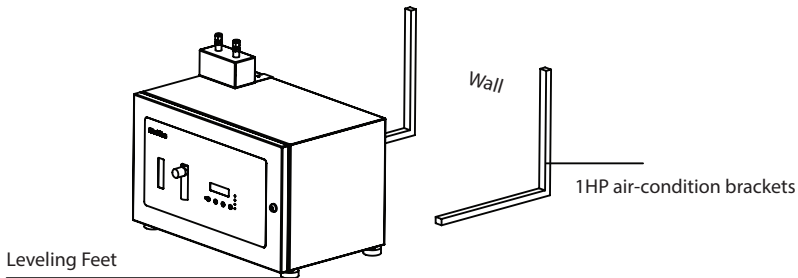

2. The Medklinn PRO AS300D/AS500D is secured to the brackets using its 4 leveling feet.

NOTE – Make sure the air inlet is clear from any blockages

Installation of Nozzle

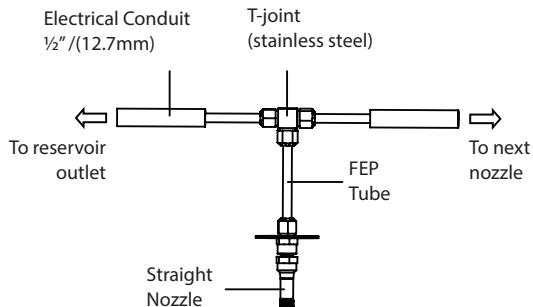

Electrical Conduit 1/2" (12.7mm)	Protects the FEP tubes which runs through it
T-joint (stainless steel)	Channels the Active Oxygen to different Straight Nozzles
FEP Tube	Channels the Active Oxygen from the device to the Straight Nozzles
Straight Nozzle (stainless steel)	Outlet for the Active Oxygen to the environment
Nylon Butterfly Anchor	Secures the Straight Nozzle to the ceiling
Screws 3.5 x 40 mm (stainless steel)	Secures the Straight Nozzle to the Nylon Butterfly Anchor

1. Identify suitable locations to install the Straight Nozzles.
NOTE: The nozzles need a minimum clearance radius of 0.6m from any object (eg. walls, lightings, speakers, sprinklers etc.) and at least 2m from return air vents
2. Plan a path for the FEP Tube starting from the device to the last Straight Nozzle.
3. Lay down the Electrical Conduits along the planned path.
4. Slot in the FEP Tube through the Electrical Conduits.
NOTE: Do not bend more than 30° when laying down the FEP Tubes as it will damage the tube walls/restrict the Active Oxygen flow through the FEP Tubes.
5. Connect multiple Straight Nozzles along the FEP Tube path each with a T-joint.
6. Connect the FEP Tubes to the Straight Nozzles and device's Reservoir outlet.

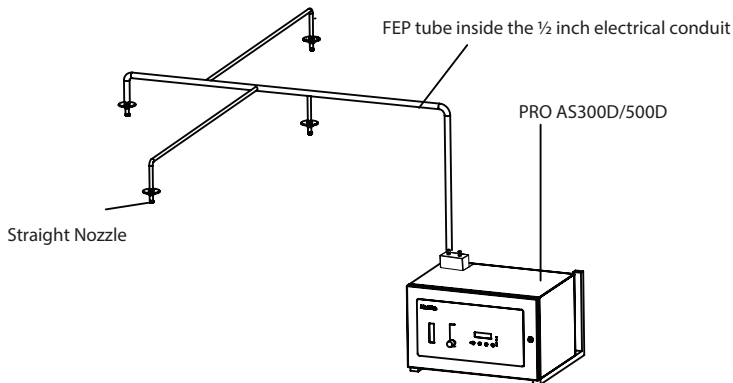

7. The Straight Nozzle is secured to the ceiling by using the Nylon Butterfly Anchor and two Stainless Steel screws.

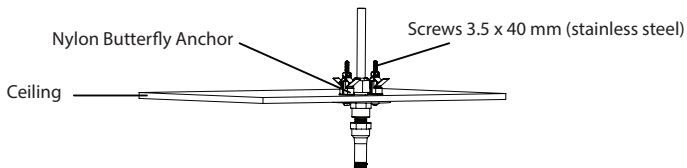

BASIC MAINTENANCE

Cleaning the Fan Filter

1. Turn off the AC power outlet. Make sure the light at the ON/OFF Button is not lit.
2. Remove the Fan Filter by pulling out the Filter Cover.

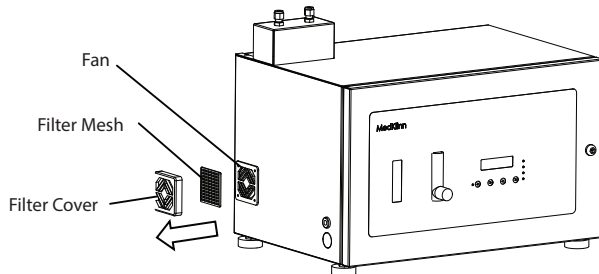

3. Brush the Filter Mesh with a soft bristle brush. Rinse and dry the Filter Cover. Wipe the Fan gently with a dry cloth.

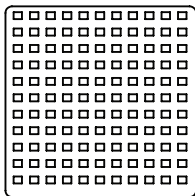

Filter Mesh

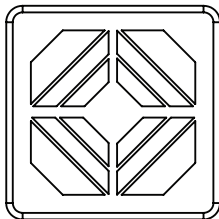

Filter Cover

4. Assemble the Fan Filter in proper order and reattach it to the Fan.
5. Clean the Fan Filter once a month or when it is clogged up with dirt/dust which may block the Fan from functioning (A clogged up filter will damage the fan).

For more information, please log on to www.medklinn.com

